

 Center Parcs

Manuel d'utilisation / Operating manual

Les Hauts de Bruyères



Sommaire

1 Cuisine 1-6

- 1.1 [Lave-vaisselle](#) 1
- 1.2 [Micro-ondes Whirpool](#) 2-3
- 1.3 [Micro-ondes Electrolux](#) 4
- 1.4 [Machine à café \(Comfort\)](#) 5
- 1.5 [Nescafé Dolce Gusto](#) 6

2 Salle d'eau 7-15

- 2.1 [Baignoire Balnéo \(Premium\)](#) 7
- 2.2 [Baignoire Balnéo Thalassor \(VIP\)](#) 8-9
- 2.3 [Baignoire Balnéo Aquarine \(VIP\)](#) 10
- 2.4 [Douche Hammam Urban](#) 11
- 2.5 [Douche Hammam Jedo](#) 12
- 2.6 [Douche Hammam Tylette](#) 13
- 2.7 [Sauna Infrarouge](#) 14
- 2.8 [Sauna électrique](#) 15

3 Salon 16-19

- 3.1 [Cheminée](#) 16
- 3.2 [Thermostat](#) 17-19

Cuisine

1.1 Lave-vaisselle

Il est important de bien fermer la porte **AU MAXIMUM 3 SECONDES** avant le lancement du lave-vaisselle.







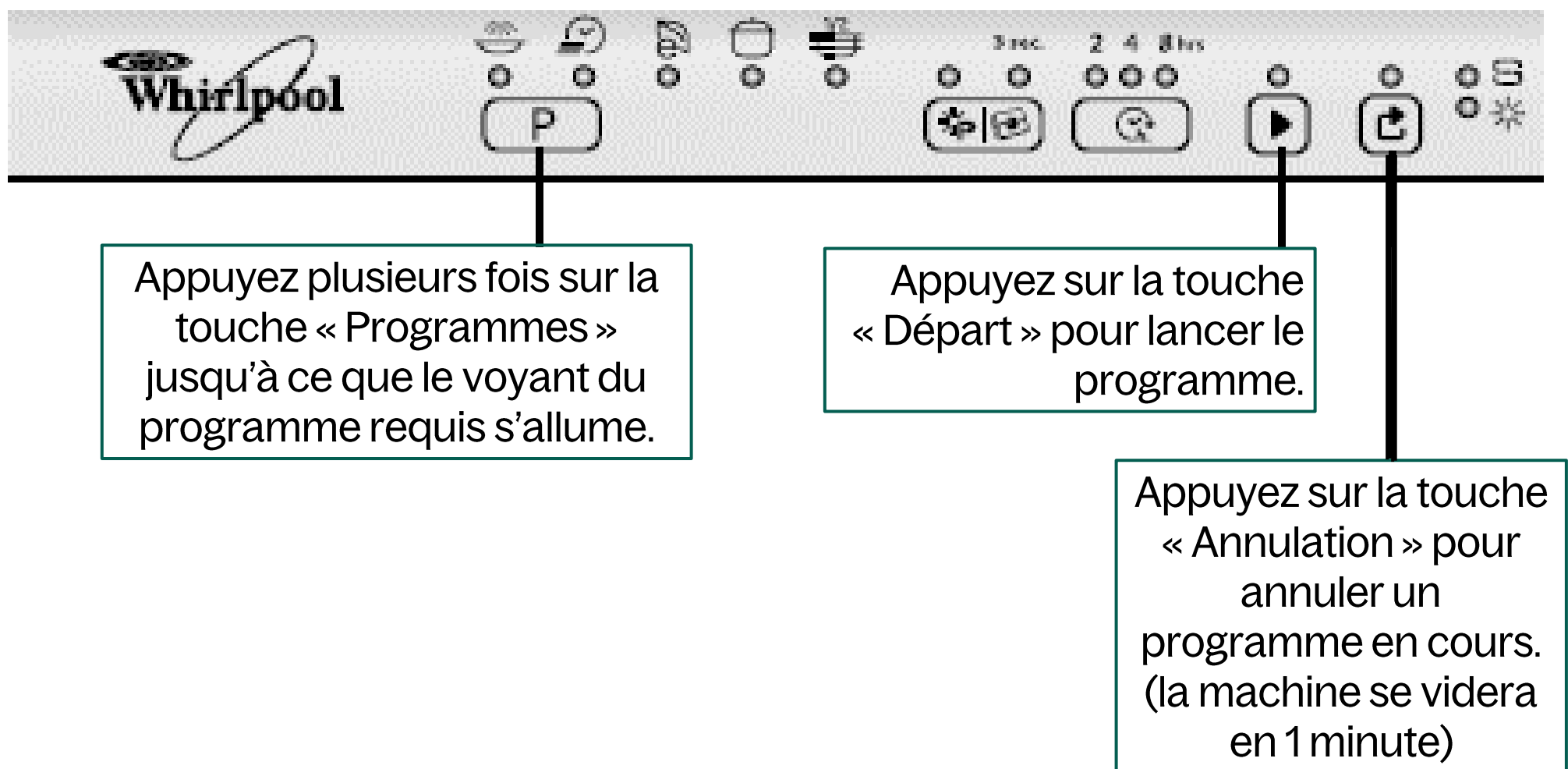

Tableau des programmes

P	Programmes	Fonctions supplémentaires	Conseils pour le chargement
1	 Trempage à froid	Départ différé	Vaisselle qui sera lavée plus tard.
2	 Rapide 45°C	Départ différé	Légèrement sale, sans résidus d'aliments secs.
3	 Eco²⁾ 50°C	Départ différé Power Clean	Normalement sale. Programme d'économie d'énergie.
4	 Intensif 70°C	Départ différé Power Clean	Programme conseillé pour une vaisselle très sale, notamment pour poêles et casseroles.
5	 Demi-Charge 50°C	Départ différé	Pour la moitié d'une charge normale de vaisselle peu ou normalement sale.

Cuisine

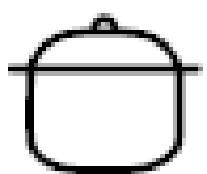
1.2 Micro-ondes Whirpool

- Micro-ondes 1:



Cuisson / réchauffage



- ▶ 1: Appuyez sur +/- pour régler le temps de cuisson
- ▶ 2: Appuyez plusieurs fois sur la touche POWER pour régler la puissance
- ▶ 3: Appuyez sur START

Grill



- ▶ 1: Appuyez sur GRILL
- ▶ 2: Appuyez sur +/- pour régler le temps de cuisson
- ▶ 3: Appuyez sur START

Grill + Cuisson



- ▶ 1: Appuyez sur GRILL
- ▶ 2: Appuyez plusieurs fois sur la touche POWER pour régler la puissance
- ▶ 3: Appuyez sur +/- pour régler le temps de cuisson
- ▶ 4: Appuyez sur START

Cuisine

1.2 Micro-ondes Whirpool

- Micro-ondes 2:



Cuisson / Réchauffage :

- ▶ 1: Tournez le bouton minuteur pour sélectionner le temps de cuisson
- ▶ 2: Appuyez plusieurs fois sur la touche puissance pour sélectionner la puissance souhaitée
- ▶ 3: Appuyez sur Start

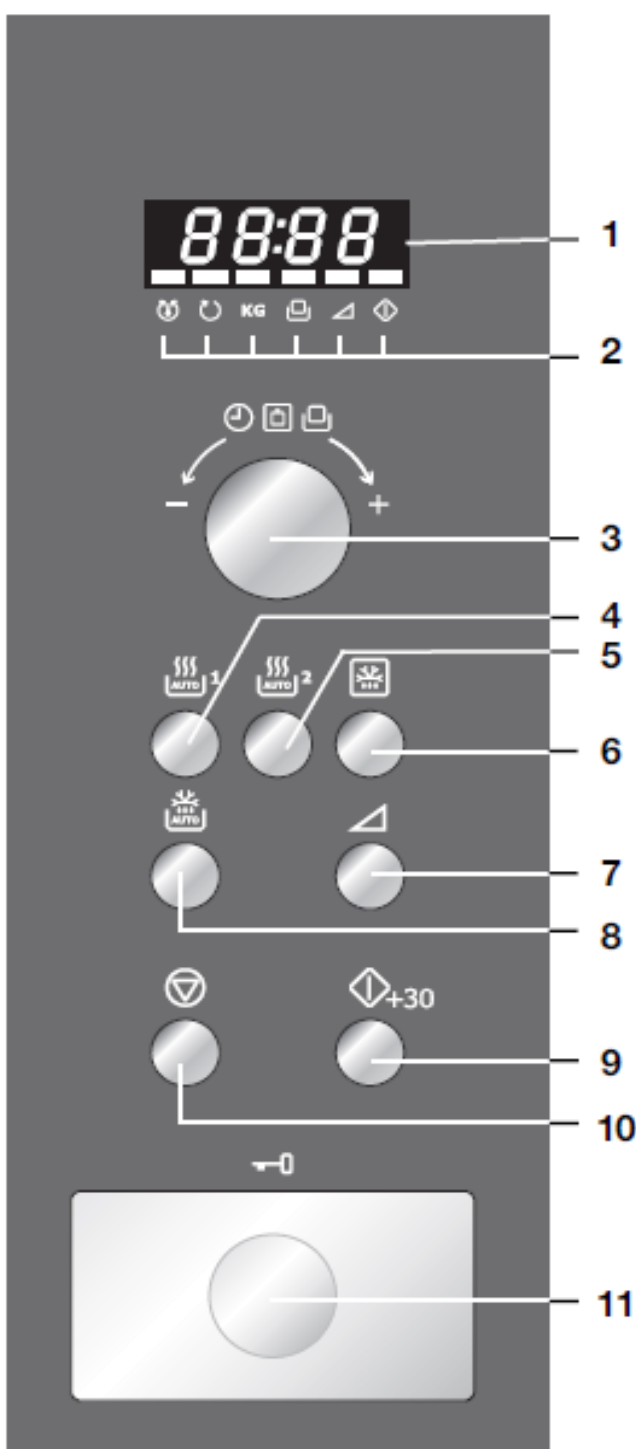

1 Affichage numérique

2 Indicateurs

L'indicateur approprié clignotera ou s'allumera juste au-dessus de chaque symbole suivant l'instruction. Quand un indicateur clignote, appuyez sur la touche correspondante (portant le même symbole) ou effectuez l'action nécessaire.

- ☞ Remuer
- ↻ Retourner
- KG Poids
- ☐ Portion
- ▲ Niveau de puissance micro-ondes
- ◊ Indicateur de cuisson en cours

3 Bouton rotatif **MINUTEUR/POIDS/PORTION**

4 Touche CUISSON AUTOMATIQUE 1
Appuyez pour sélectionner l'un des 2 programmes automatiques.

5 Touche CUISSON AUTOMATIQUE 2
Appuyez pour sélectionner l'un des 2 programmes automatiques.

6 Touche CUISSON DEPUIS L'ÉTAT CONGELÉ
Appuyez pour sélectionner l'un des 3 programmes automatiques.

7 Touche de NIVEAU DE PUISSANCE MICRO-ONDES

8 Touche DÉCONGÉLATION AUTOMATIQUE

Appuyez pour sélectionner l'un des 5 programmes automatiques.

9 Touche START/+30

10 Touche STOP

11 Touche OUVERTURE DE LA PORTE

Cuisine









1.3 Micro-ondes Electrolux



- ▶ 1: Tournez le bouton minuteur pour sélectionner le temps de cuisson
- ▶ 2: Appuyez plusieurs fois sur la touche puissance pour sélectionner la puissance souhaitée
- ▶ 3: Appuyez sur Start

BANDEAU DE COMMANDE

1 AFFICHAGE numérique

 Gril	 Plus/Moins
 Micro-ondes	 Décongélation automatique pain
 Cuisson combinée	 Décongélation automatique
 Horloge	 Quantité
 Etapes de cuisson	

2 Symboles CUISSON AUTOMATIQUE

3 Touche CUISSON AUTOMATIQUE

4 Touche DÉCONGÉLATION AUTOMATIQUE

5 Touche NIVEAUX DE PUISSANCE

6 Touche GRIL

7 Bouton rotatif MINUTEUR/POIDS

8 Touche START/+30

9 Touche STOP

10 Touche OUVERTURE DE LA PORTE

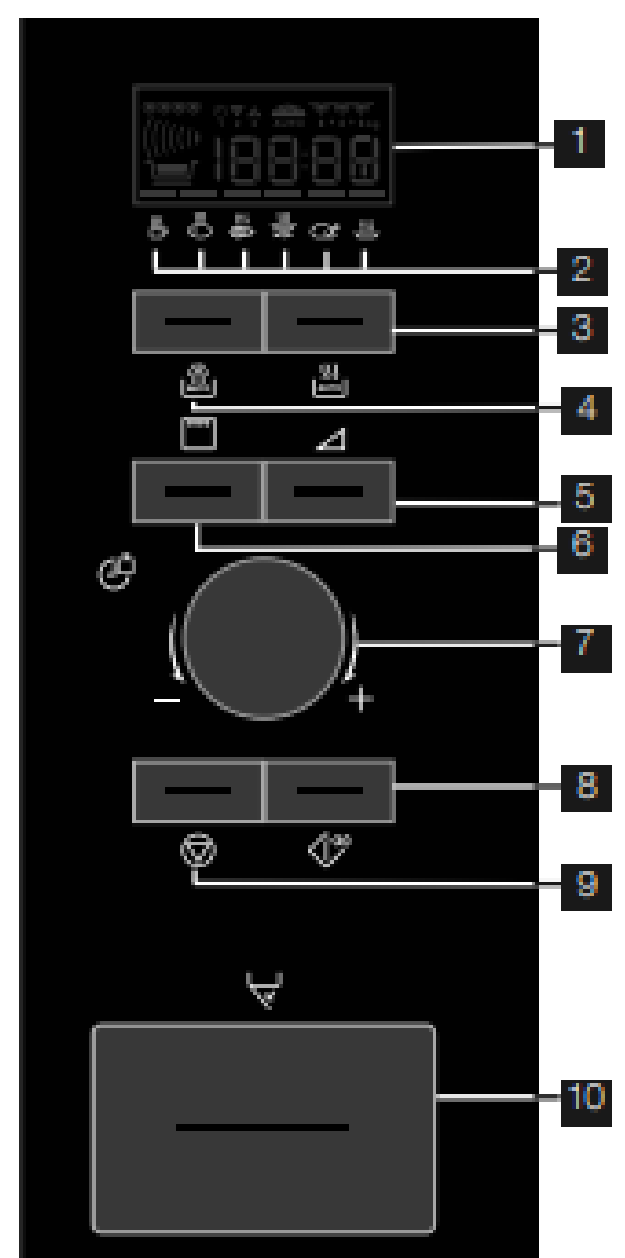

Cuisine

1.4 Machine à café (Comfort)



- 1: Couvercle du réservoir d'eau
- 2: Indicateur du niveau d'eau
- 3: Porte filtre pivotant avec filtre amovible
- 4: Verseuse en verre avec couvercle conservateur d'arôme
- 5: Plaque chauffante
- 6: Interrupteur avec témoin lumineux
- 7: Plaque signalétique (à la base)
- 8: Cordon d'alimentation

Cuisine

1.5 Nescafé Dolce Gusto

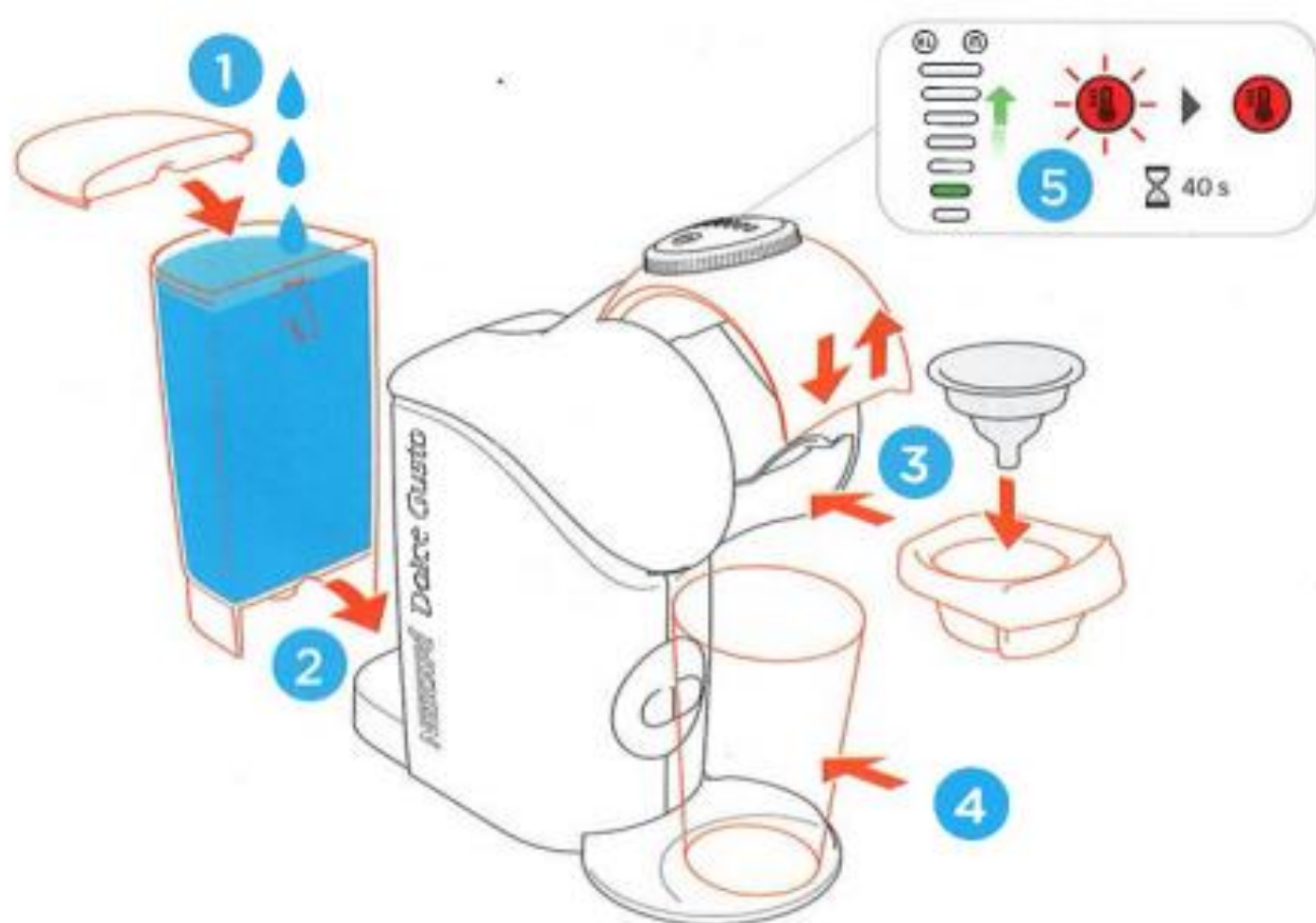

Salle d'eau

2.1 Baignoire Balnéo

Vous disposez d'une balnéo standard si vous retrouvez ce bouton près de la baignoire.



Attention, pour ce type de baignoire balnéo, il est important de remplir l'eau au minimum 15 cm au-dessus des buses avant toute utilisation.

Salle d'eau

2.2 Baignoire Balnéo Thalassor

- Baignoire Balnéo :



Marche / Arrêt

Appuyez sur le bouton pour mettre la pompe en marche ou l'arrêter. Si le bouton clignote, cela signifie qu'il n'y a pas suffisamment d'eau dans la baignoire.



Puissance de massage

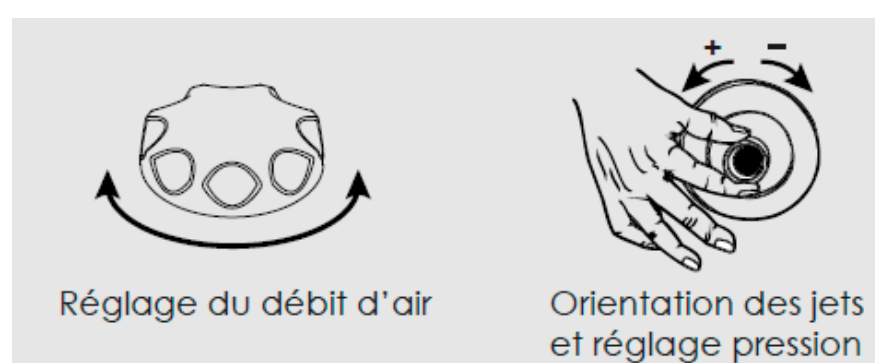

- 1 : Ajustez la puissance des jets en jouant sur la molette cannelée de réglage de débit d'air située sur la baignoire.
- 2 : Orientez et fermez certains hydrojets afin d'augmenter ou de reporter la puissance du massage.

Fonction de rinçage

- 1 : Après chaque utilisation, utilisez la fonction rinçage de votre baignoire pour rincer la baignoire,
- 2 : Pour cela, lorsque la baignoire est vide, mettez l'inverseur de fonction sur la position « Rinçage », puis ouvrez à fond les robinets d'eau chaude et d'eau froide durant 1 minute, avant de les refermer.

Salle d'eau

2.2 Baignoire Balnéo Thalassor

- Baignoire Balnéo :



Ordinateur avec écran tactile + Télécommande

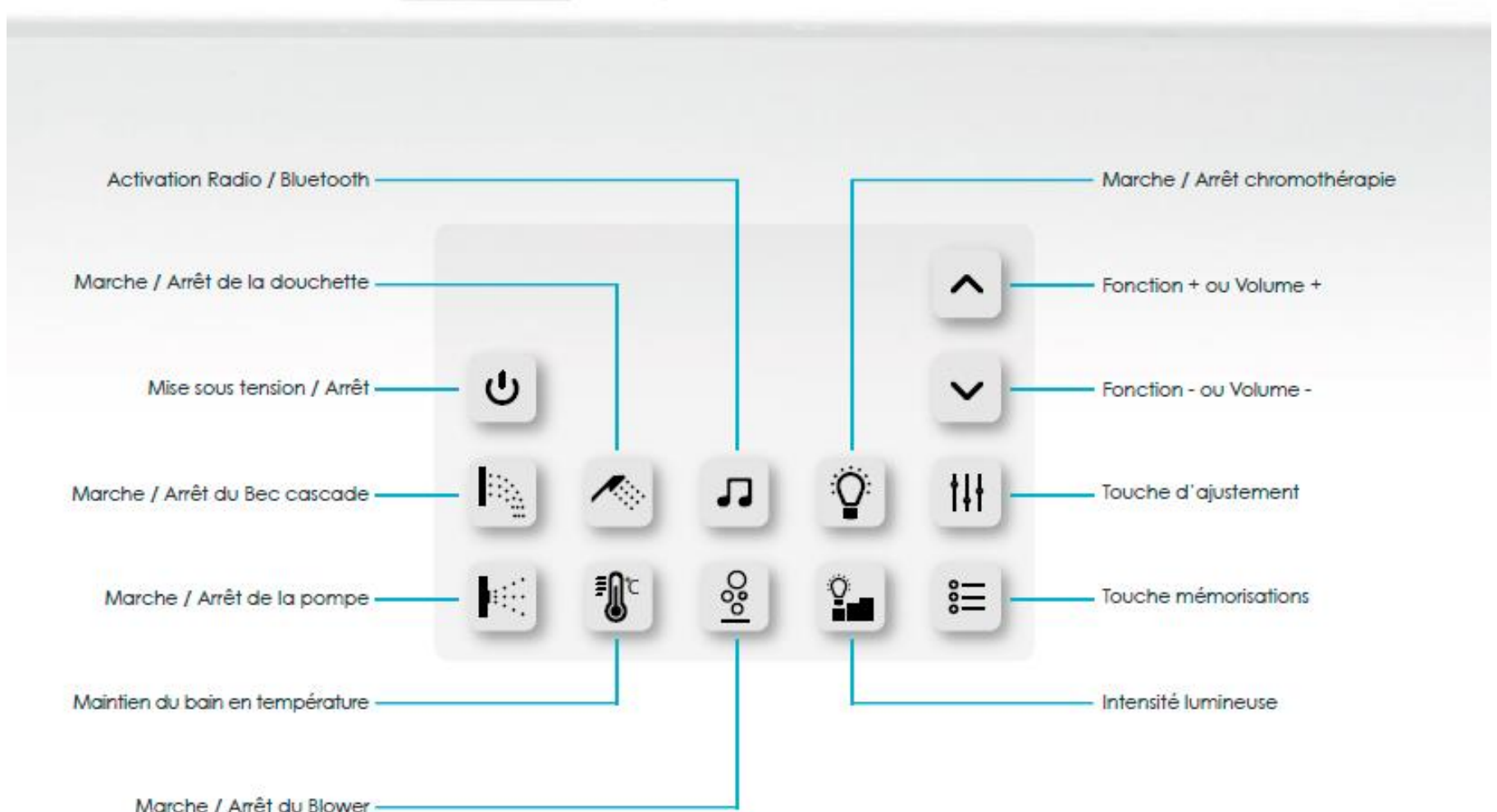

Salle d'eau

2.3 Baignoire Balnéo Aquarine



AQUARINE
Spirit of Wellness

MIX'INTENSE



SPOT CHROMO 8 COULEURS
CHROMO SPOTLIGHT, 8 colours (optional)
CHROMO-SPOT 8 Farben (nach Wahl)
SPOT CHROMO 8 kleuren (optioneel)
FOCO CHROMO 8 colores (opcional)
PONTO CHROMO 8 cores (opcional)



MASSAGE EAU
WATER MASSAGE
WASSERMASSE
WATERMASSAGE
MASAJE DE AGUA
MASSAGEM DE ÁGUA



MASSAGE TURBO
TURBO MASSAGE
TURBO MASSAGE
TURBO MASSAGE
MASAJE TURBO
MASSAGEM TURBO

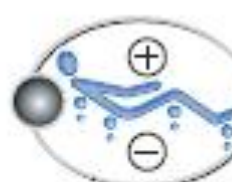

MASSAGE AIR
AIR MASSAGE
LUFTMASSAGE
AIR MASSAGE
MASAJE DE AIRE
MASSAGEM COM AR



MASSAGE DRAINAGE / ZONING
DRAINING / ZONING MASSAGE
MASSAGE DRAINAGE / ZONING
DRAINING MASSAGE / ZONING
MASAJE DE DRENAJE / POR ZONAS
MASSAGEM DRENAGEM / ZONAGEM

AIR'INTENSE



EAU'INTENSE



PROGRAMME AUTOMATIQUE "TONIC"
AUTOMATIC "TONING" PROGRAMME
AUTOMATISCHES "TONIC"-PROGRAMM
AUTOMATISCH PROGRAMMA "TONISCH"
PROGRAMA AUTOMÁTICO "TÓNICO"
PROGRAMA AUTOMÁTICO "TONIC"



PROGRAMME AUTOMATIQUE "RELAX"
AUTOMATIC "RELAX" PROGRAMME
AUTOMATISCHES "RELAX"-PROGRAMM
AUTOMATISCH PROGRAMMA "RELAX"
PROGRAMA AUTOMÁTICO "RELAX"
PROGRAMA AUTOMÁTICO "RELAX"

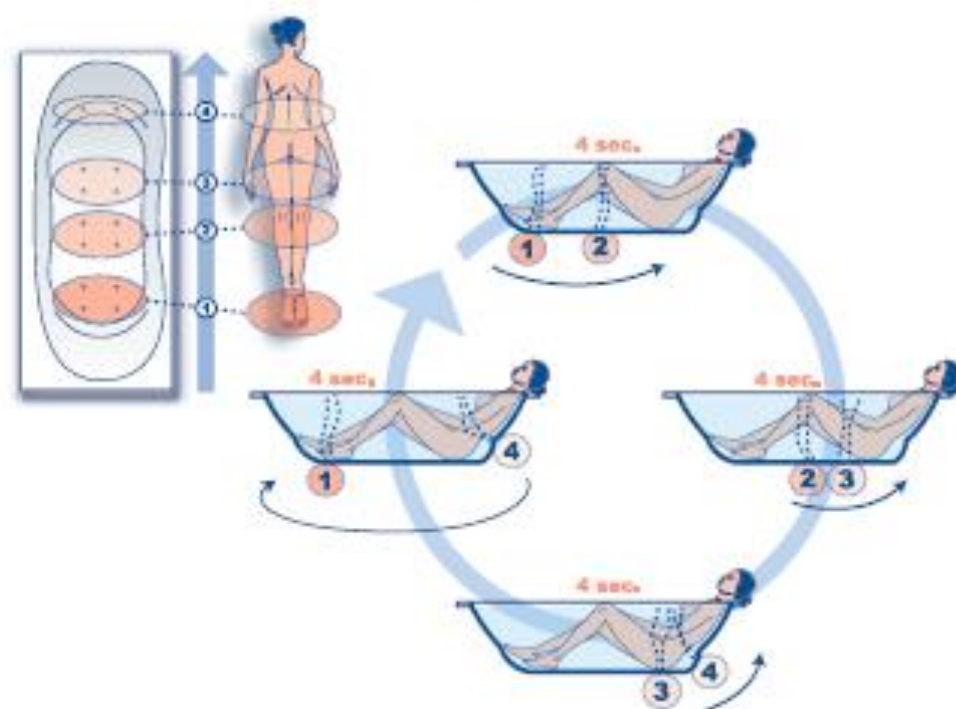

Salle d'eau

2.4 Douche Hammam Urban

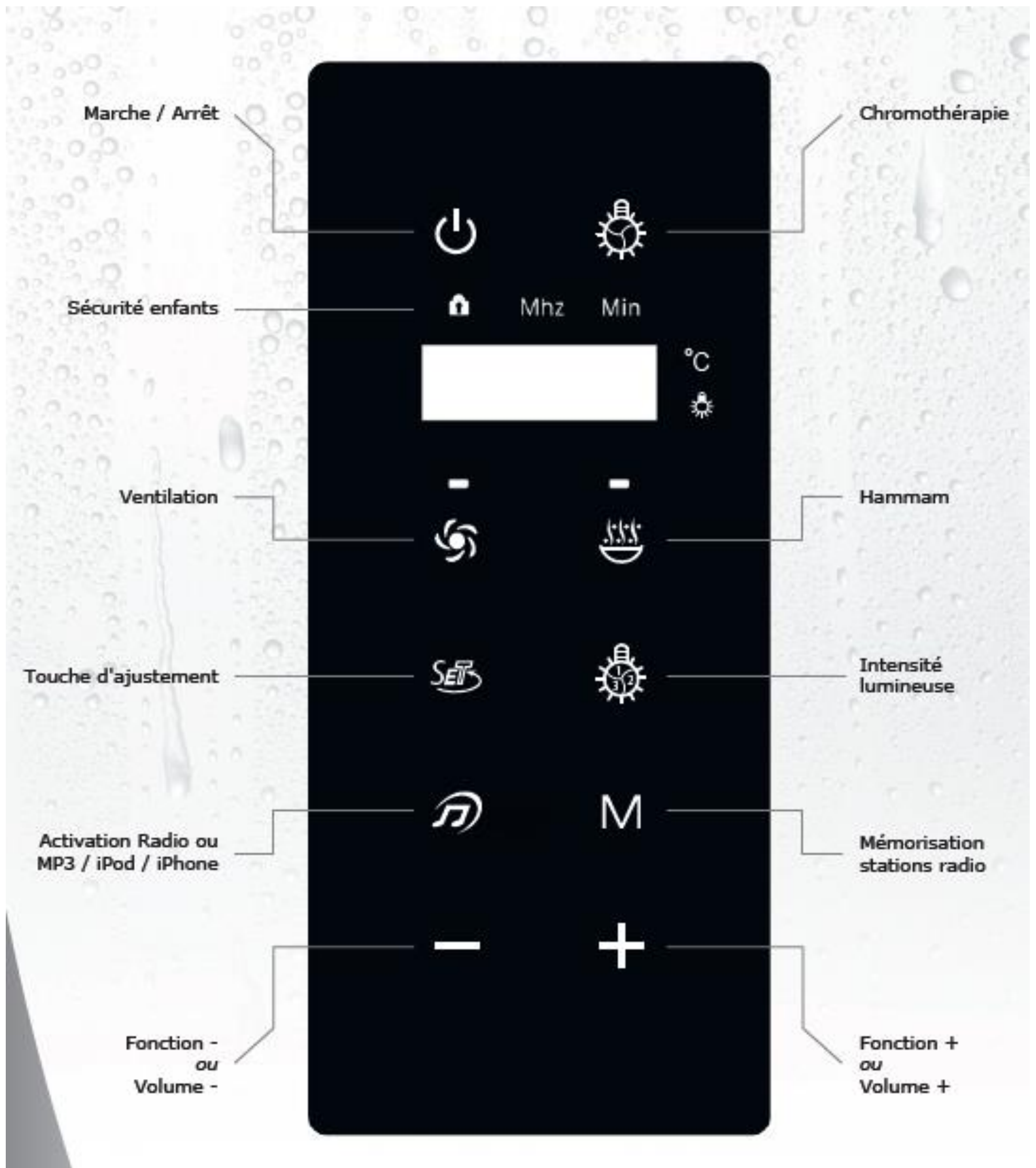

Salle d'eau

2.5 Douche Hammam Jedo

Il est important d'effectuer un préchauffage. Mettez en fonctionnement le hammam au moins 30 minutes avant de prendre votre bain de vapeur.



- P Touche Programmes
- ▼ Réglage du temps / Sélection des programmes intermittents de P1 à P4
- ☰ Marche / Arrêt Hydrojets
 - ▶ Démarrage de la pompe après 2 secondes.
- ☀ Eclairage
- ☁ Hammam (si option)
 - ▶ Le hammam ne peut pas fonctionner avec l'hydromassage.

Salle d'eau

2.6 Douche Hammam Tylette

Eclairage

S'allume automatiquement au démarrage de l'équipement et s'éteint automatiquement à l'arrêt de celui-ci. L'éclairage peut également être commandé manuellement en pressant sur le bouton « Light » (référence au bouton 1).

Fonctions

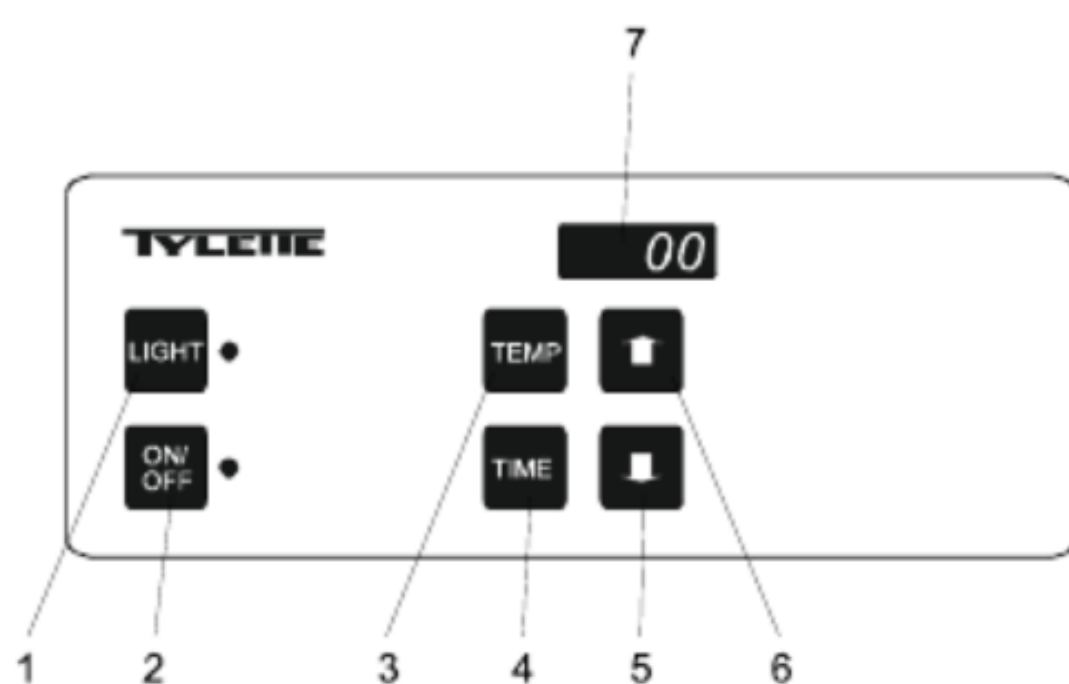





- ▶ 1: Appuyez sur le bouton pour déclencher l'éclairage
- ▶ 2: Appuyez sur ON pour mettre en marche et sur OFF arrêter
- ▶ 3: Pressez sur le bouton pour régler la température
- ▶ 4: Programmez la durée
- ▶ 5: Ajustez pour diminuer la température ou la durée
- ▶ 6: Adaptez pour augmenter la température ou la durée

Salle d'eau

2.7 Sauna Infrarouge

Touches de commande



-  Eclairage de la cabine
-  Marche - Arrêt
-  Mode de programmation
-  Augmenter la valeur
-  Diminuer la valeur

Salle d'eau

2.8 Sauna électrique

Réglage de la température

Rechercher la température idéale à l'aide de l'échelle graduée en chiffres Romains !

- ▶ 1: Commencer par exemple par la position IV. Si vous désirez une température + ou - élevée, changer de réglage.
- ▶ 2: Vous pouvez ensuite conserver ce réglage pour d'autres séances de sauna

Réglage de la durée

Les premiers chiffres 1-2-3 donnent la durée de fonctionnement, les 9 autres chiffres indiquent le temps de présélection.

- ▶ Mise en marche immédiate : passer au chiffre 3 puis revenir sur la position qui correspond à la durée de la séance (1, 2 ou 3 heures). Le timer s'arrête automatiquement sur la position 0.
- ▶ Mise en marche automatique : tourner le bouton jusqu'à la position qui correspond à la durée de retardement (= temps qui précède la mise en marche). Le timer s'arrête automatiquement sur la position 0.
- ▶ Vous pouvez, quand vous voulez, passer sur la position 0 pour arrêter manuellement le sauna ou changer le programme.

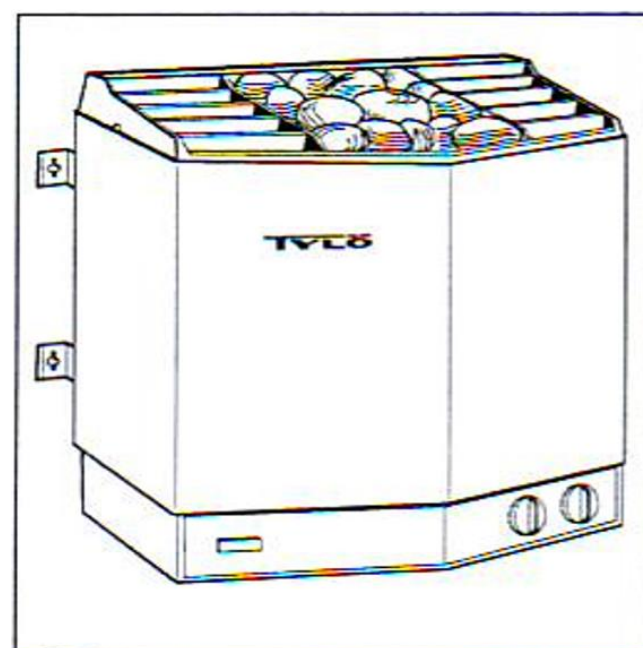

Salon

3.1 Cheminée

- ▶ Laisser la trappe ouverte
- ▶ Insérer une bûche calorifique en vente au supermarché
- ▶ Installer la grille de protection et profiter de votre cheminée d'ambiance

Il est interdit de cuire de la nourriture et d'utiliser du bois de forêt !

Salon

3.2 Thermostat

- Thermostat 1:

Choix du mode / Choice of Mode / Auswahl der Betriebsart / Scelta della modalità / Elección del modo / Wybór trybu / Keuze van de modus

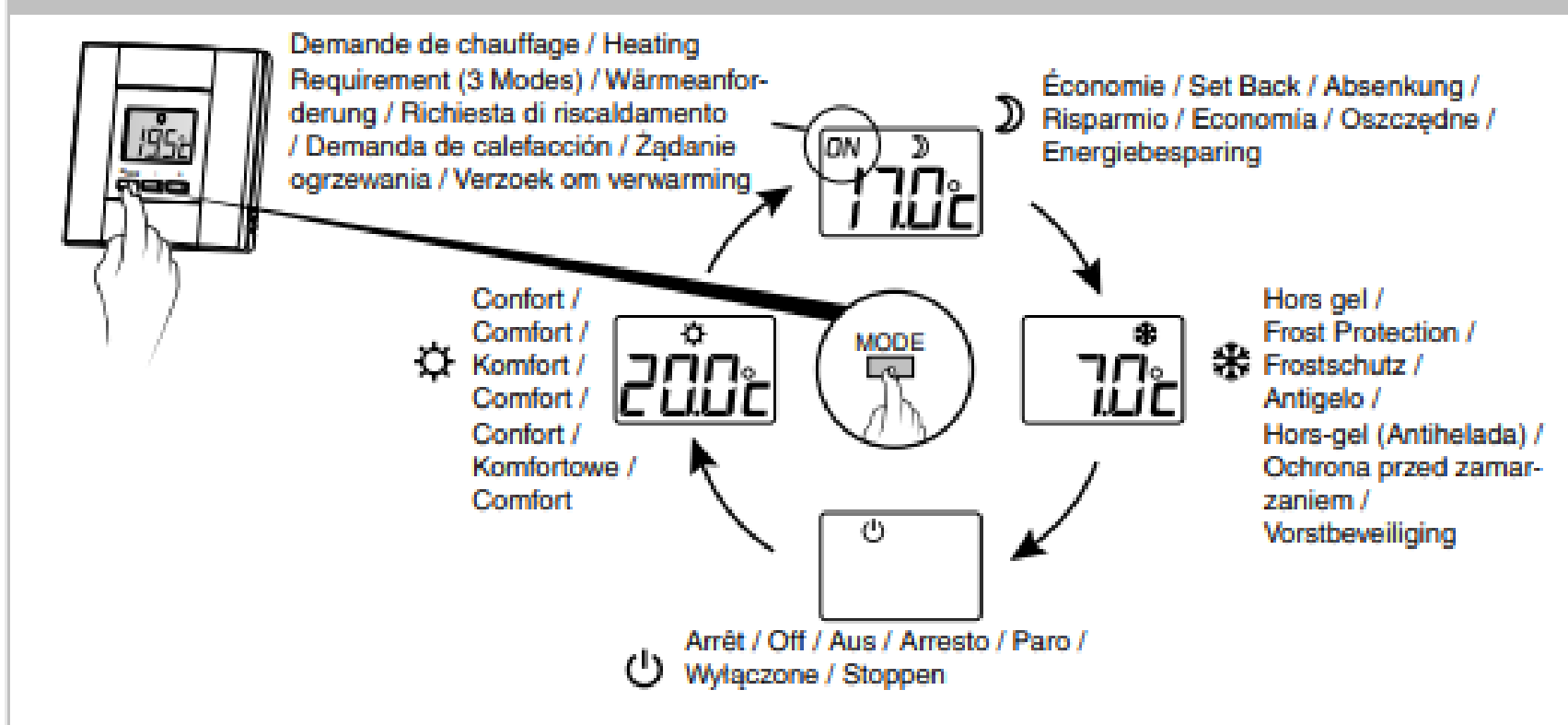

Réglage température de consigne / Temperature setting / Einstellung der Solltemperatur / Regolazione temperatura di riferimento / Ajuste de temperatura de consigna / Ustawianie zadanej temperatury / Instelling van de richttemperatuur

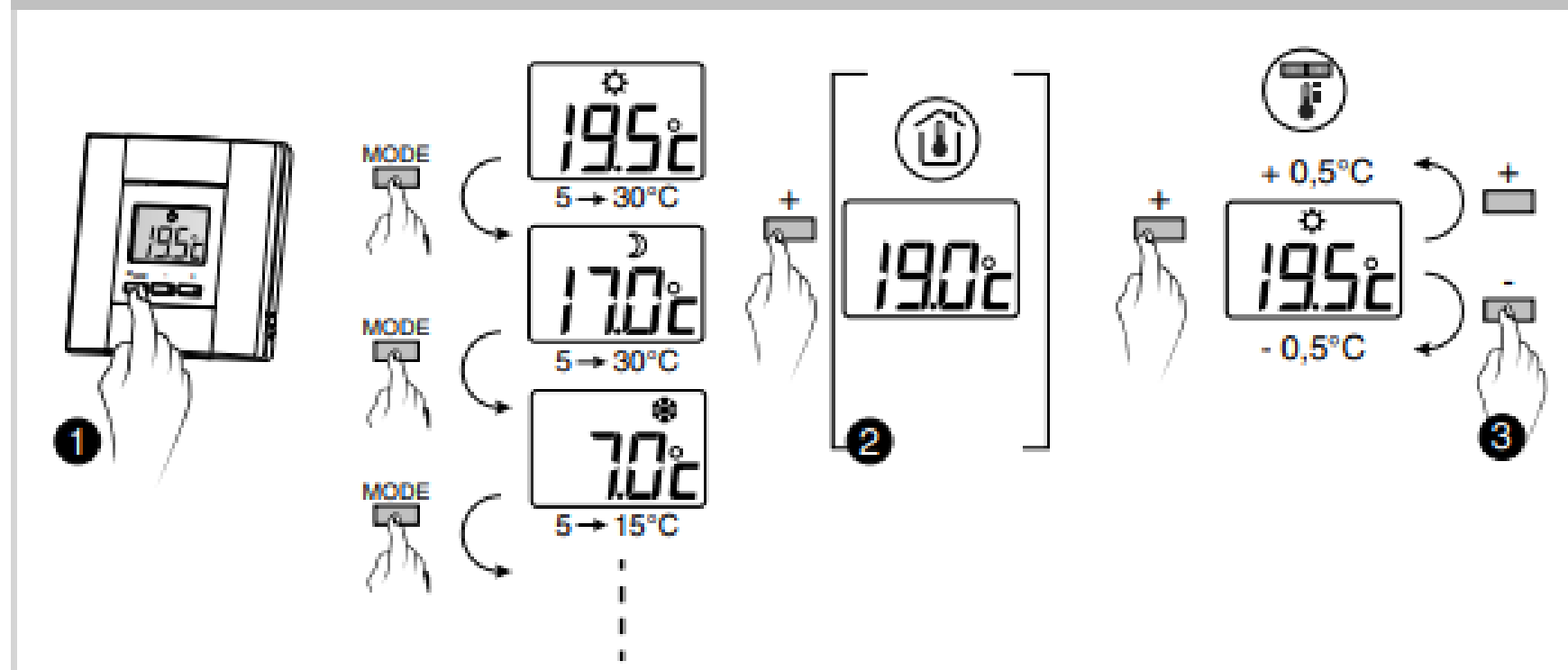

Ce thermostat fonctionne à piles.

S'il ne s'allume pas, il faut peut-être les changer.

Salon

3.2 Thermostat

- Thermostat 2:

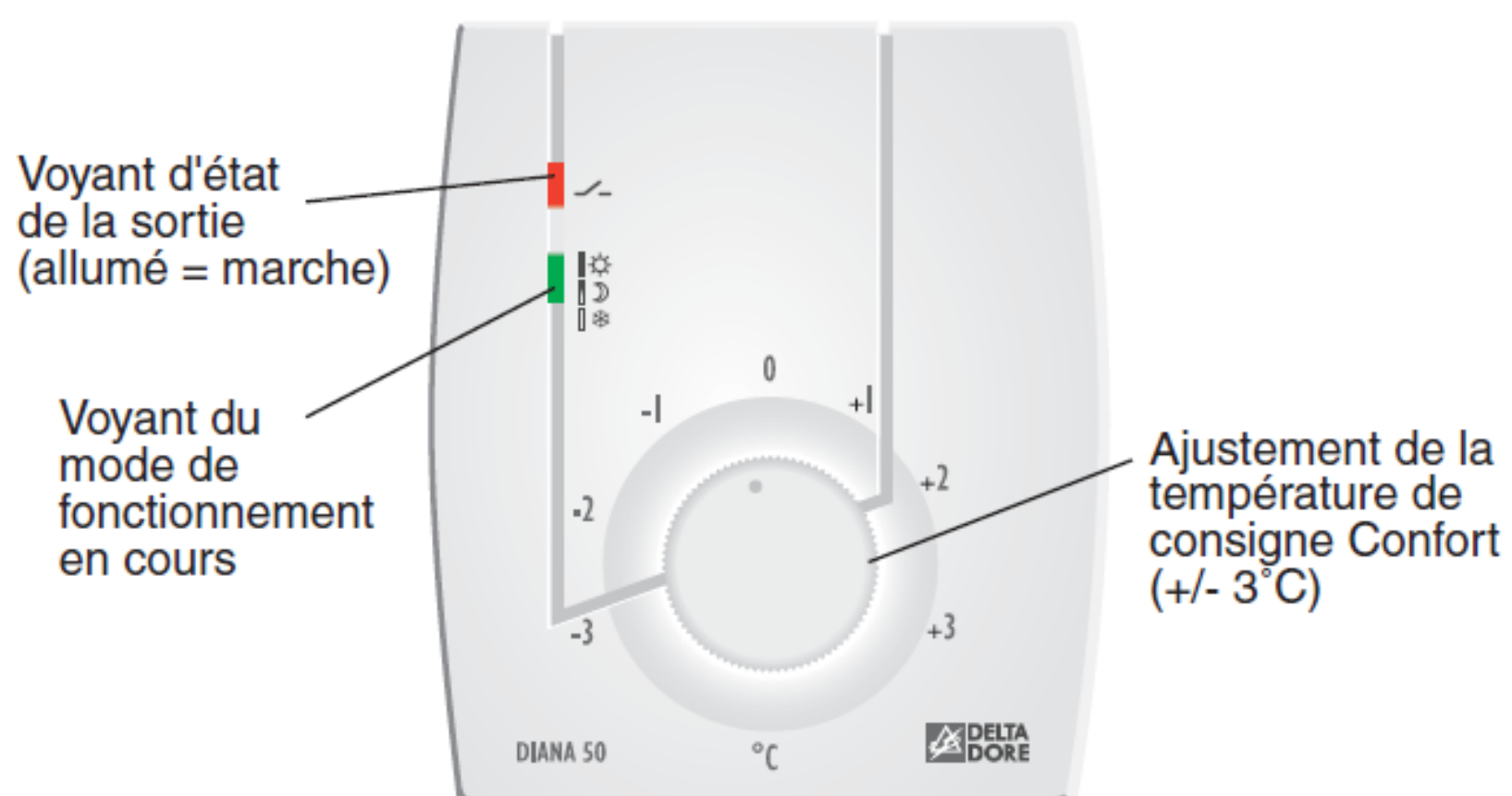

- ▶ Position -3 = 17°C
- ▶ Position -2 = 18°C
- ▶ Position -1 = 19°C
- ▶ Position 0 = 20°C
- ▶ Position 1 = 21°C
- ▶ Position 2 = 22°C
- ▶ Position 3 = 23°C

Salon

3.2 Thermostat

- Thermostat 3:



Table of contents

1 Kitchen 21-26

- 1.1 [Dishwashers](#) 21
- 1.2 [Whirlpool microwaves](#) 22-23
- 1.3 [Electrolux microwaves](#) 24
- 1.4 [Coffee machine \(Comfort\)](#) 25
- 1.5 [Nescafe Dolce Gusto](#) 26

2 Bathroom 27-35

- 2.1 [Whirlpool bath \(Premium\)](#) 27
- 2.2 [Thalassor whirlpool bath \(VIP\)](#) 28-29
- 2.3 [Aquarine whirlpool bath \(VIP\)](#) 30
- 2.4 [Urban Hammam shower](#) 31
- 2.5 [Jedo Hammam shower](#) 32
- 2.6 [Tylette Hammam shower](#) 33
- 2.7 [Infrared sauna](#) 34
- 2.8 [Electric sauna](#) 35

3 Living Room 36-39

- 3.1 [The chimney](#) 36
- 3.2 [Thermostat](#) 37-39

Kitchen

1.1 Dishwashers

It is important to close the door tightly AT MAXIMUM 3 SECONDS before starting the dishwasher.

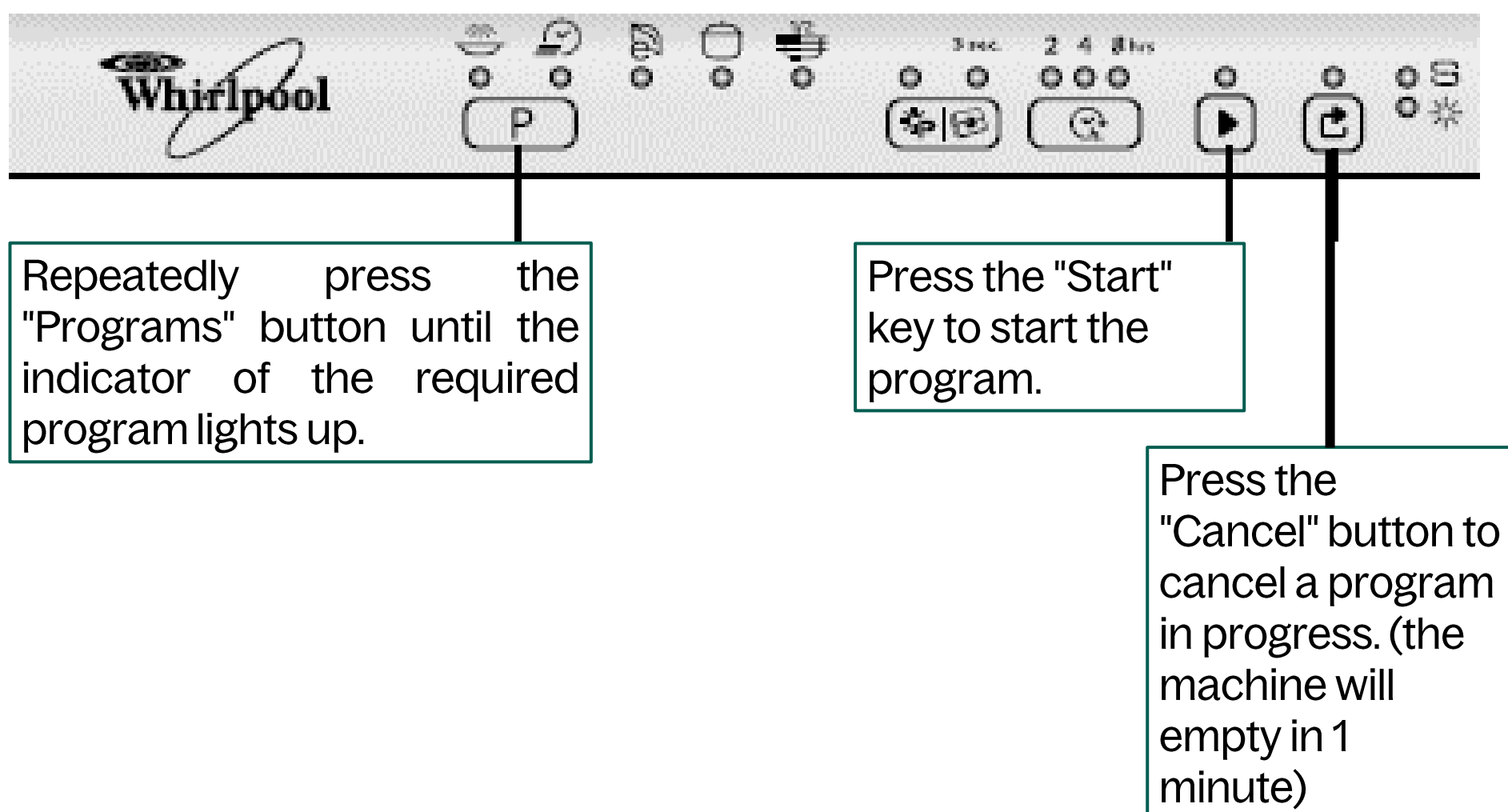

Repeatedly press the "Programs" button until the indicator of the required program lights up.

Press the "Start" key to start the program.

Press the "Cancel" button to cancel a program in progress. (the machine will empty in 1 minute)

Table of programs				
P	Programs	Additional functions	Advice for the load	
1	Trempage	Cold	Forward starting	Dishes which will be later washed
2	Fast	45°C	Forward starting	Dishes which will be later washed
3	Eco	50°C	Forward starting Power Clean	Normally dirty. Programm of energy saving
4	Intensif	70°C	Forward starting Power Clean	Program advised for a very dirty dishes, in particular for stoves and pans
5	Demi-Charge	50°C	Forward starting	For half of a normal load (responsibility) of dishes (crookery) little or normally dirty

Kitchen

1.2 Whirlpool microwaves

Microwave 1



Cooking / reheating



- 1: Press +/- to settle the cooking time
- 2: Press several times on the touch POWER to settle the power
- 3: Press START

Grill (put on the metal grill)

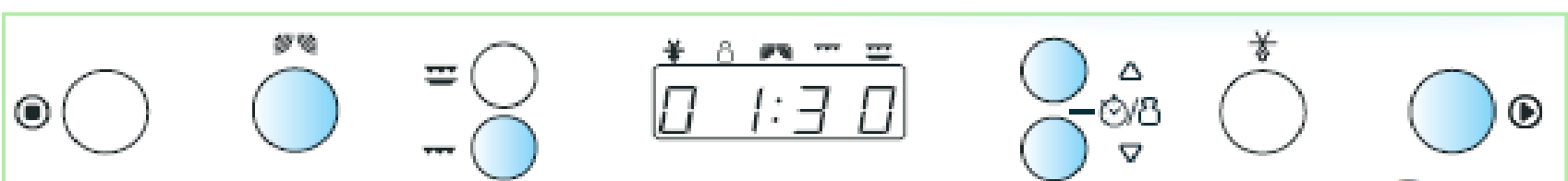

- 1: Press GRILL
- 2: Press +/- to settle the cooking time
- 3: Press START

Grill + Cooking (not put the metallic railing)

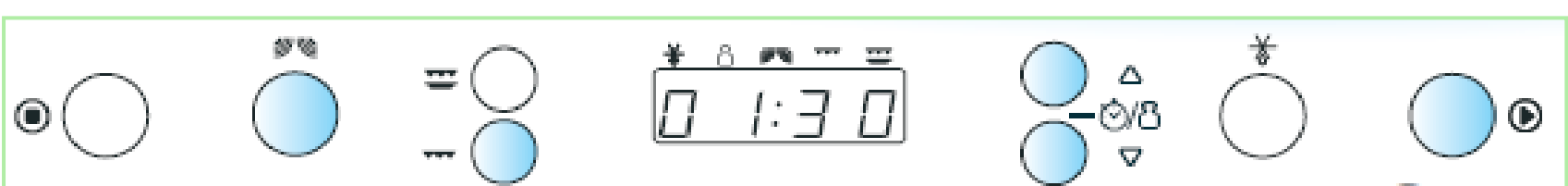

- 1: Press GRILL
- 2: Press several time on the touch POWER to settle the power .
- 3: Press +/- to settle the cooking time
- 4: Press START

Kitchen

1.2 Whirlpool microwaves

Microwave 2



COOKING / REHEATING:

- 1: Turn the control button to settle the cooking time
- 2: Push several times on the touch POWER to select the power
- 3: Push on the touch JET START

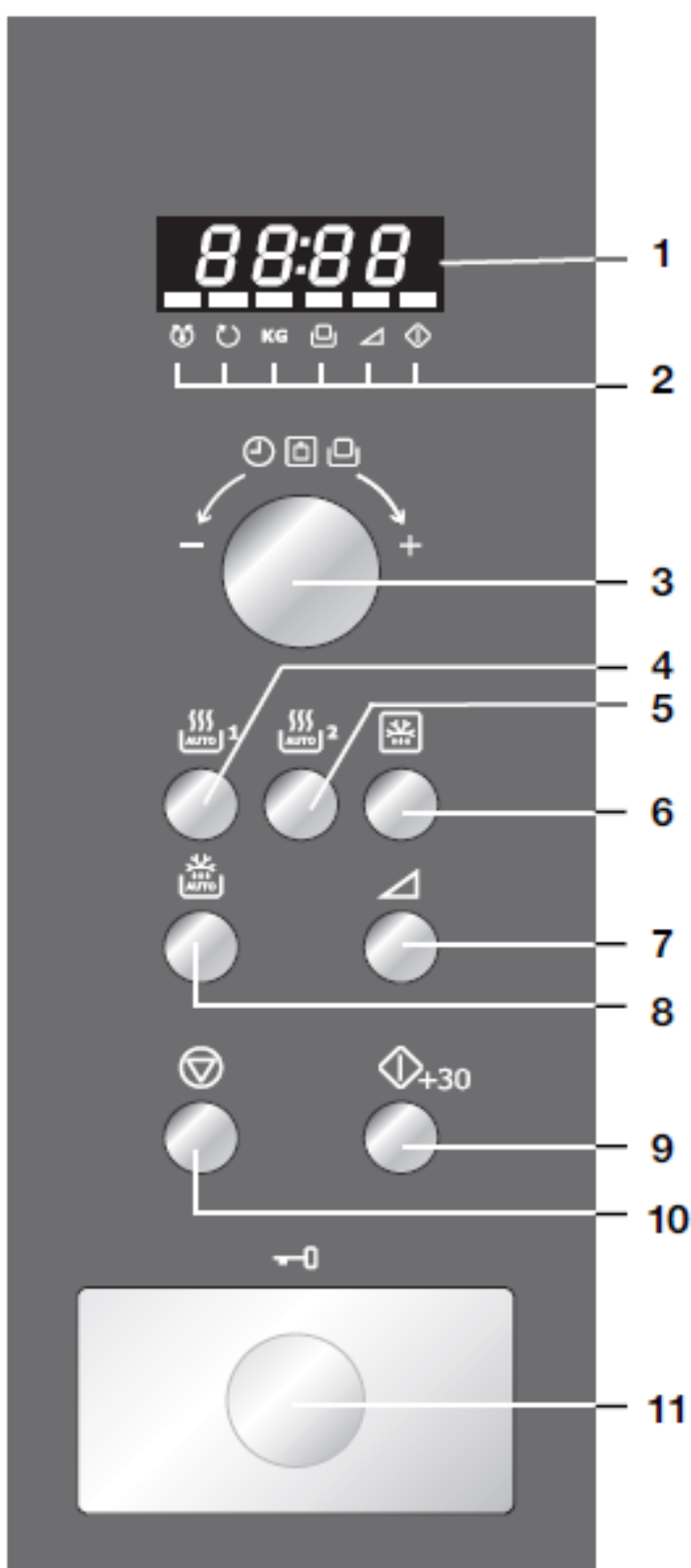

- 1 **Affichage numérique**
- 2 **Indicateurs**
L'indicateur approprié dignotera ou s'allumera juste au-dessus de chaque symbole suivant l'instruction. Quand un indicateur dignote, appuyez sur la touche correspondante (portant le même symbole) ou effectuez l'action nécessaire.
 - ☞ Remuer
 - ↻ Retourner
 - KG Poids
 - ☐ Portion
 - ▲ Niveau de puissance micro-ondes
 - ◊ Indicateur de cuisson en cours
- 3 **Bouton rotatif MINUTEUR/POIDS/PORTION**
- 4 **Touche CUISSON AUTOMATIQUE 1**
Appuyez pour sélectionner l'un des 2 programmes automatiques.
- 5 **Touche CUISSON AUTOMATIQUE 2**
Appuyez pour sélectionner l'un des 2 programmes automatiques.
- 6 **Touche CUISSON DEPUIS L'ÉTAT CONGELÉ**
Appuyez pour sélectionner l'un des 3 programmes automatiques.
- 7 **Touche de NIVEAU DE PUISSANCE MICRO-ONDES**
- 8 **Touche DÉCONGÉLATION AUTOMATIQUE**
Appuyez pour sélectionner l'un des 5 programmes automatiques.
- 9 **Touche START/+30**
- 10 **Touche STOP**
- 11 **Touche OUVERTURE DE LA PORTE**

Kitchen

1.3 Electrolux microwaves









COOKING / REHEATING:

- 1: Turn the control button to settle the cooking time
- 2: Push several times on the touch POWER to select the power
- 3: Push on the touch JET START

BANDEAU DE COMMANDE

1 DIGITAL DISPLAY

	Grill		More / Less
	Microwaves		Automatic thawing bread
	Combines cooking		Automatic thawing
	Clock		Quantity
	Cooking steps		

- 2 Automatic cooking light
- 3 Automatic cooking touch
- 4 Automatic thawing touch
- 5 Power level touch
- 6 Grill touch
- 7 Rotary knob timer weight
- 8 STOP touch
- 9 Door opening button

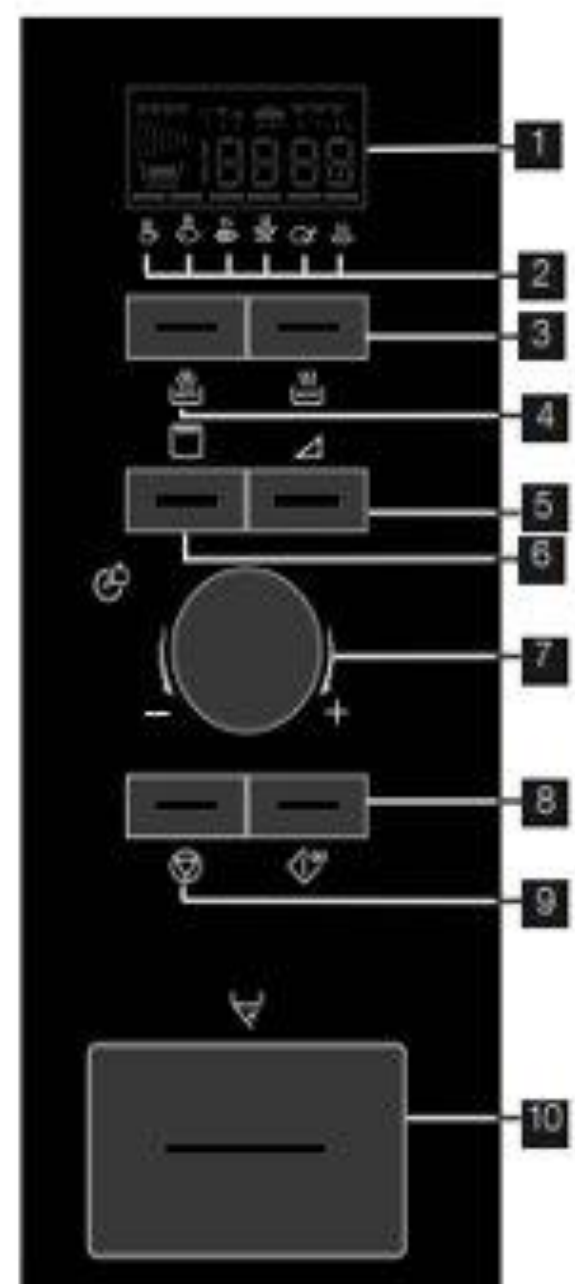

Kitchen

1.4 Coffee machine



1. Water tank cover.
2. Water level indicator
3. Swivel filter holder with removable filter
4. Glass jug with aroma-preserving lid
5. Hot plate
6. Switch with indicator light
7. Signal plate (base)
8. Power cord

Kitchen

1.5 Nescafe Dolce Gusto

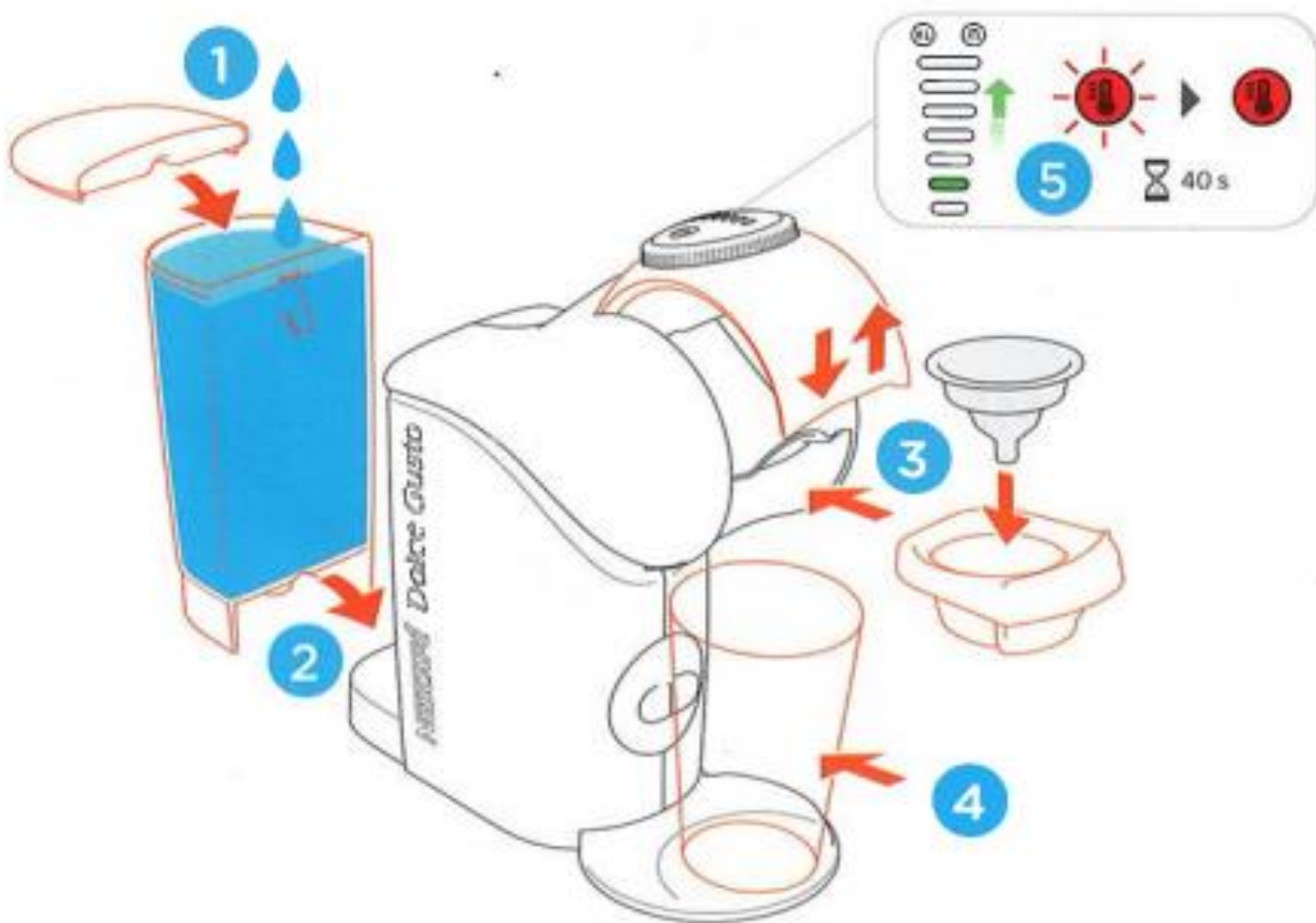

Bathroom

2.1 Whirlpool bath

You have a standard whirlpool bath if you find this button near the bath.



For this type of whirlpool bath, it's important to fill the water to at least 15 cm above the jets before use.

Bathroom

2.2 Thalassor whirlpool bath

► Balneotherapy bath Thalassor 1



On / Off

Press the button to start or stop the pump. If the button flashes, there is not enough water in the tub.



Massage power

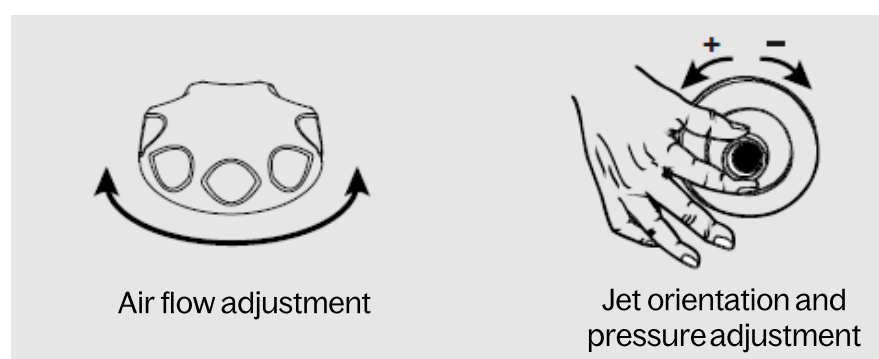

1: Adjust the power of the jets by turning the grooved airflow adjustment knob on the bathtub.

2: Turn some jets on and off to increase or defer massage power.

Rinse function

1: After each use, use your bathtub's rinse function to rinse the bathtub.

2: When the bathtub is empty, set the function switch to the "Rinse" position, then open the hot and cold water taps fully for 1 minute, before closing them again.

Bathroom

2.2 Thalassor whirlpool bath

► Balneo bathtub :



Computer with touch screen + Remote control

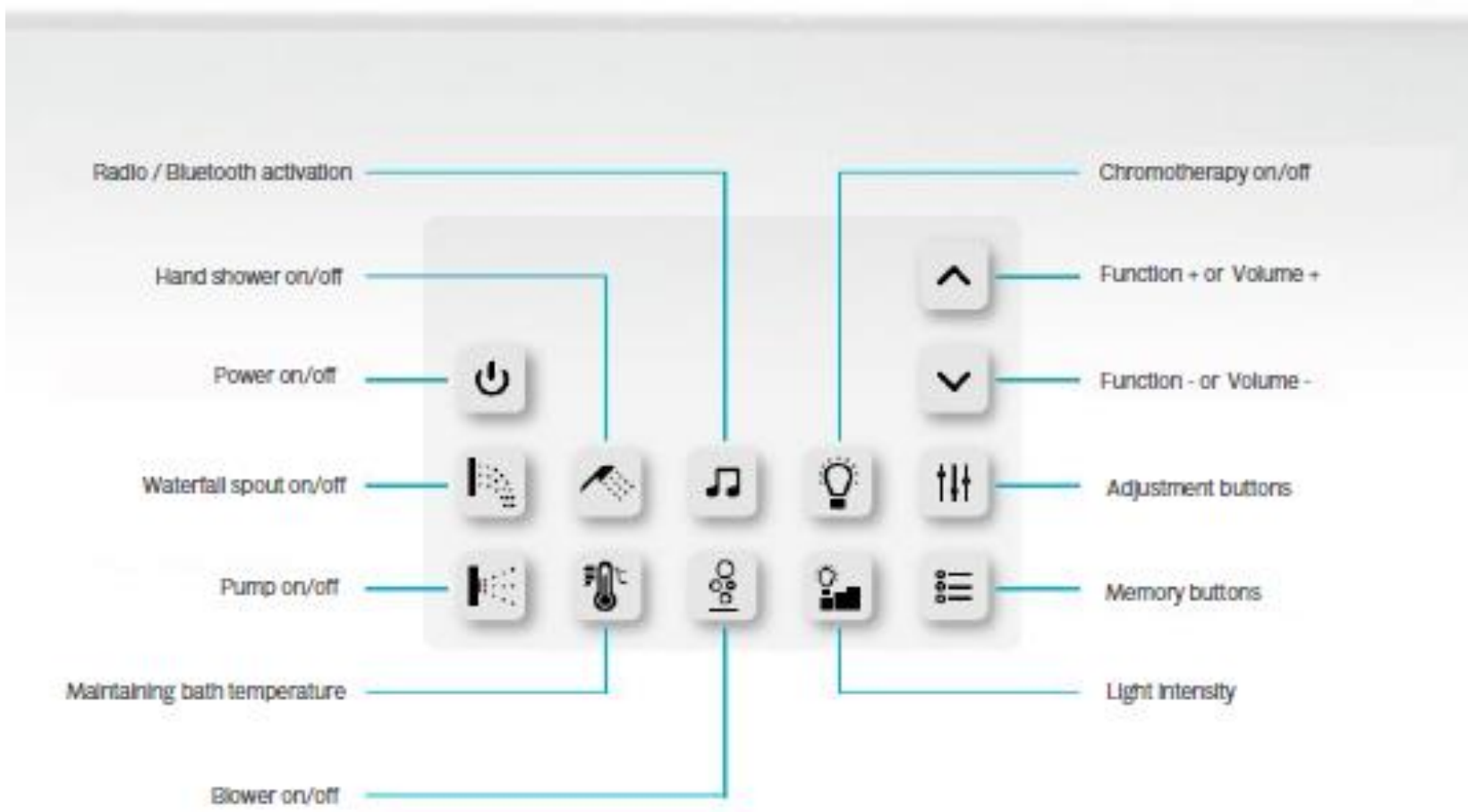

Bathroom

2.3 Aquarine whirlpool bath



AQUARINE
Spirit of Wellness

MIX'INTENSE



SPOT CHROMO 8 COULEURS
CHROMO SPOTLIGHT, 8 colours (optional)
CHROMO-SPOT 8 Farben (nach Wahl)
SPOT CHROMO 8 kleuren (optioneel)
FOCO CHROMO 8 colores (opcional)
PONTO CHROMO 8 cores (opcional)

AIR'INTENSE



MASSAGE EAU
WATER MASSAGE
WASSERMASSEGE
WATERMASSAGE
MASAJE DE AGUA
MASSAGEM DE ÁGUA



MASSAGE TURBO
TURBO MASSAGE
TURBO MASSAGE
TURBO MASSAGE
MASAJE TURBO
MASSAGEM TURBO



EAU'INTENSE



MASSAGE AIR
AIR MASSAGE
LUFTMASSAGE
AIR MASSAGE
MASAJE DE AIRE
MASSAGEM COM AR



MASSAGE DRAINAGE / ZONING
DRAINING / ZONING MASSAGE
MASSAGE DRAINAGE / ZONING
DRAINING MASSAGE / ZONING
MASAJE DE DRENAJE / POR ZONAS
MASSAGEM DRENAGEM / ZONAGEM



PROGRAMME AUTOMATIQUE "TONIC"
AUTOMATIC "TONING" PROGRAMME
AUTOMATISCHES "TONIC"-PROGRAMM
AUTOMATISCH PROGRAMMA "TONISCH"
PROGRAMA AUTOMÁTICO "TÓNICO"
PROGRAMA AUTOMÁTICO "TONIC"



PROGRAMME AUTOMATIQUE "RELAX"
AUTOMATIC "RELAX" PROGRAMME
AUTOMATISCHES "RELAX"-PROGRAMM
AUTOMATISCH PROGRAMMA "RELAX"
PROGRAMA AUTOMÁTICO "RELAX"
PROGRAMA AUTOMÁTICO "RELAX"

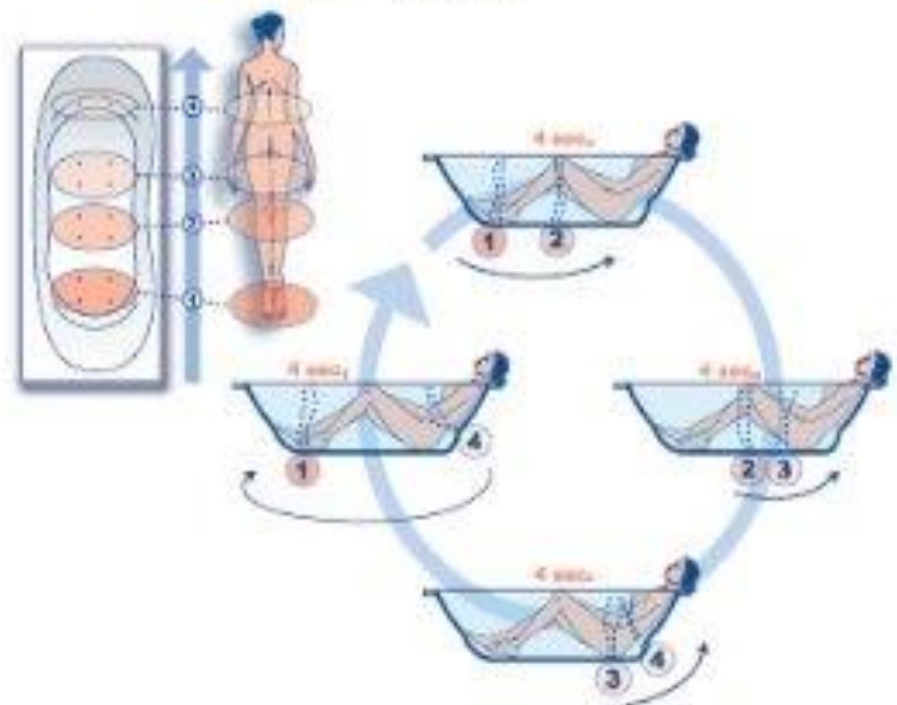

Bathroom

2.4 Hammam Urban shower

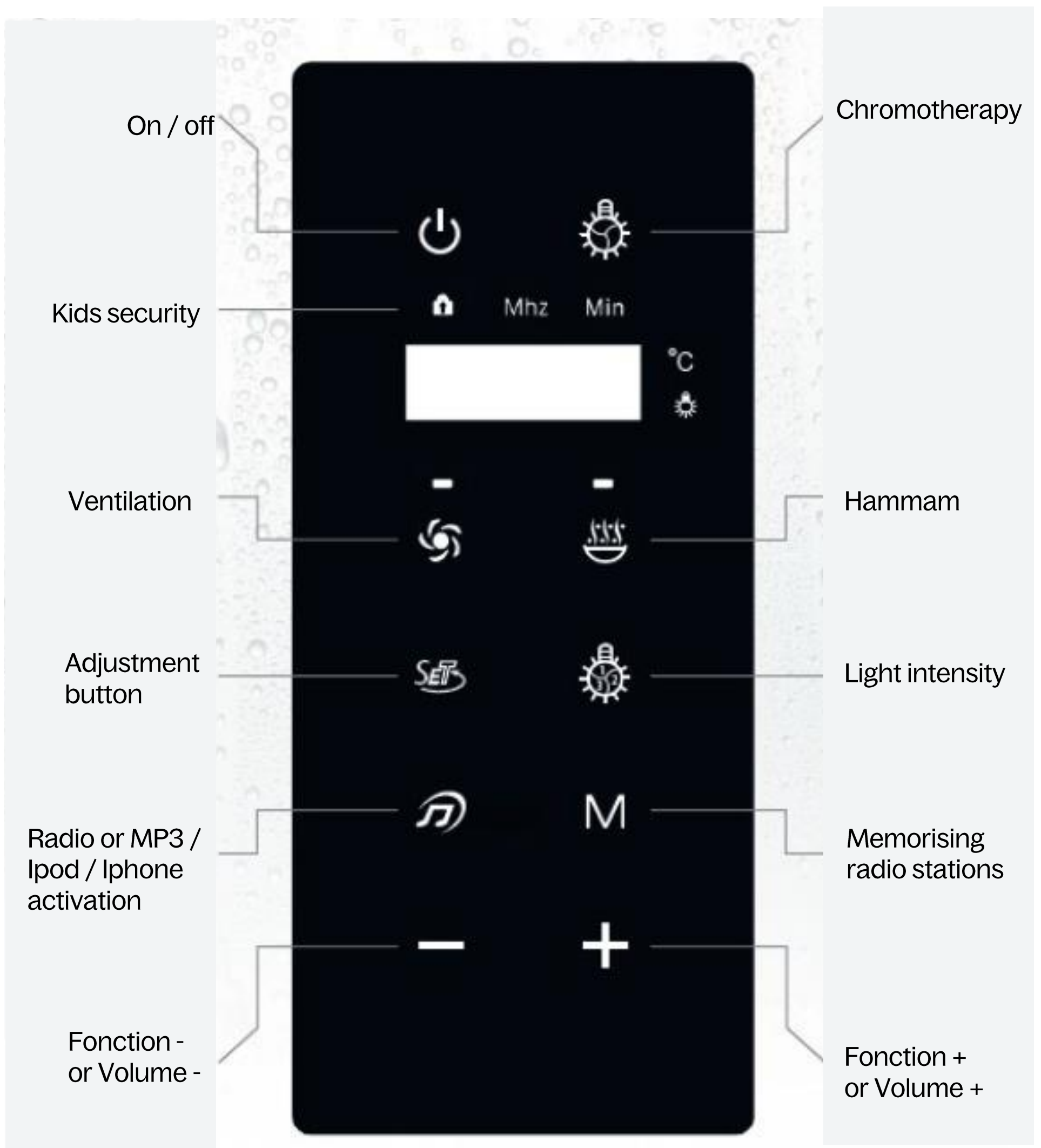

Bathroom

2.5 Hammam shower JEDO

Preheating is important. Turn on the steam bath at least 30 minutes before you take your steam bath.



- P Program button
- ▼ Time setting / Selection of intermittent programs from P1 to P4
- ≡ Start / Stop Hydrojets
Pump starts after 2 seconds.
- ☀ Lighting
- ☁ Steam bath (optional)
The hammam cannot be used with hydromassage.

Bathroom

2.6 Tylette Hammam Shower

Lighting

Switches on automatically when the equipment is started and switches off automatically when the equipment is stopped. The lighting can also be controlled manually by pressing:

1: Press button to switch on light

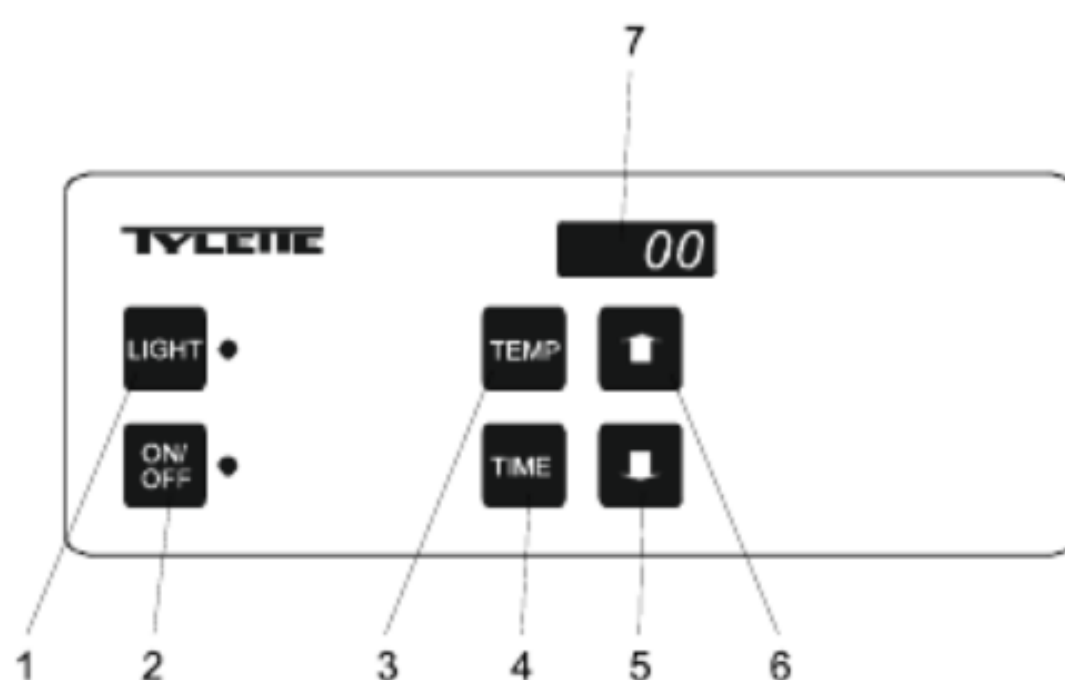

1: Press button to switch on light

2: Press ON to switch on and OFF to switch off

3: Press button to set temperature

4: Set time

5: Adjust to decrease temperature or duration





6: Adjust to increase temperature or time of the "Light" button (reference to button 1).

Bathroom

2.7 Infrared sauna

Control buttons



-  Cabin lighting
-  On - Off
-  Programming mode
-  Increase value
-  Decrease value

Bathroom

2.8 Electric sauna

Temperature settings

Find the ideal temperature using the Roman numeral scale!

- ▶ 1: Start with position IV, for example. If you want a higher or lower temperature, change the setting.
- ▶ 2: You can then keep this setting for other sauna sessions.

Time settings

The first digits 1-2-3 indicate the operating time, the other 9 digits indicate the pre-selection time.

Immediate start-up: go to number 3 then back to the position corresponding to the duration of the session (1, 2 or 3 hours). The timer will automatically stop in position O.

Automatic start-up: turn the knob to the position corresponding to the delay time (= time before start-up). The timer stops automatically in position O.

You can switch to position O at any time to stop the sauna manually or change the programme.

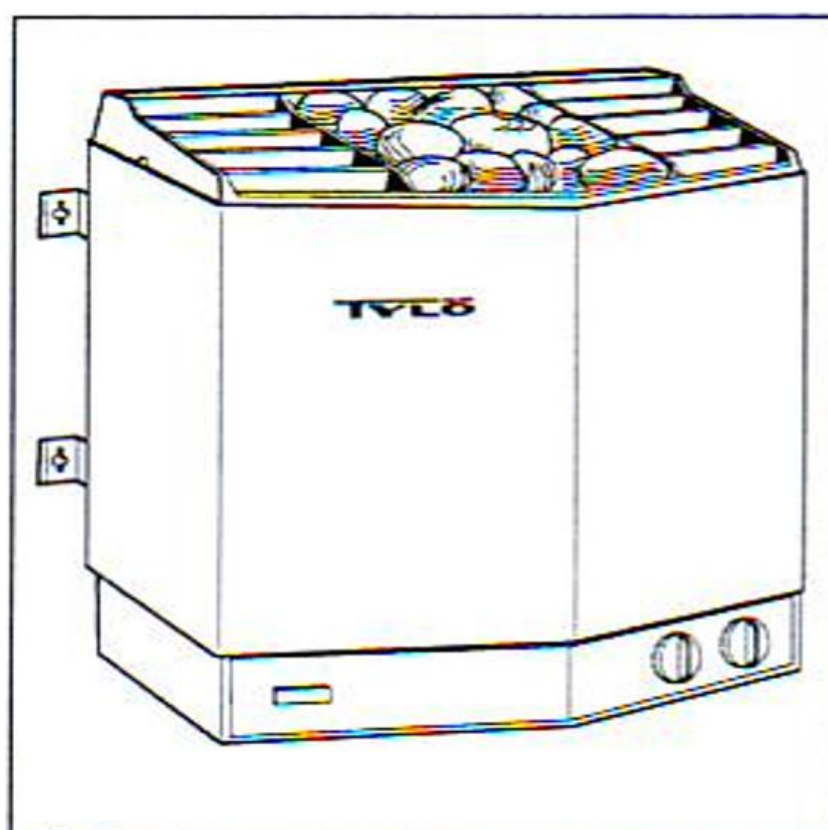

Living room

3.1 The chimney

Leave the hatch open

Insert a supermarket firelog

Install the protective grille and enjoy your fireplace

It's forbidden to cook food or use wood from the forest!

Living room

3.2 Thermostat

- Thermostat 1:

Choix du mode / Choice of Mode / Auswahl der Betriebsart / Scelta della modalità / Elección del modo / Wybór trybu / Keuze van de modus

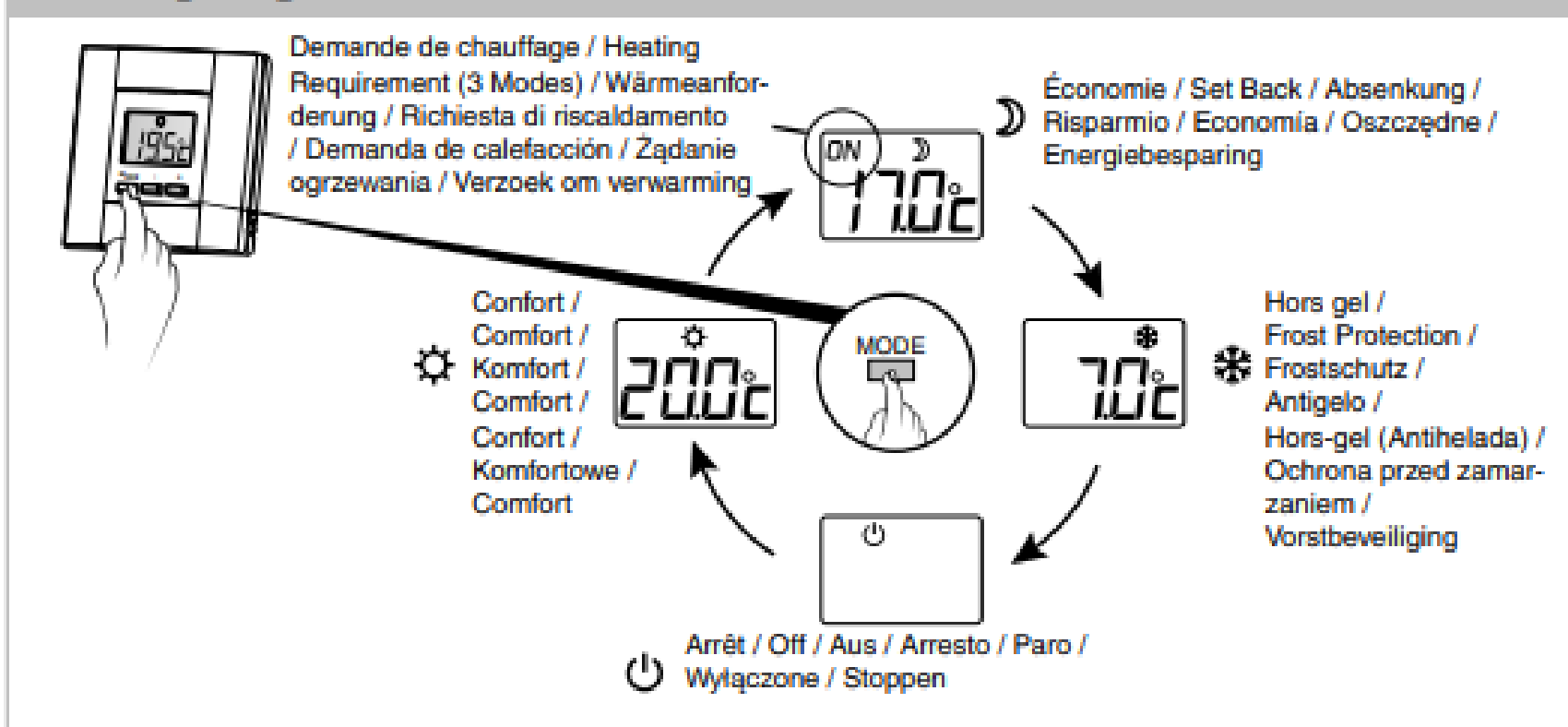

Réglage température de consigne / Temperature setting / Einstellung der Solltemperatur / Regolazione temperatura di riferimento / Ajuste de temperatura de consigna / Ustawianie zadanej temperatury / Instelling van de richttemperatuur

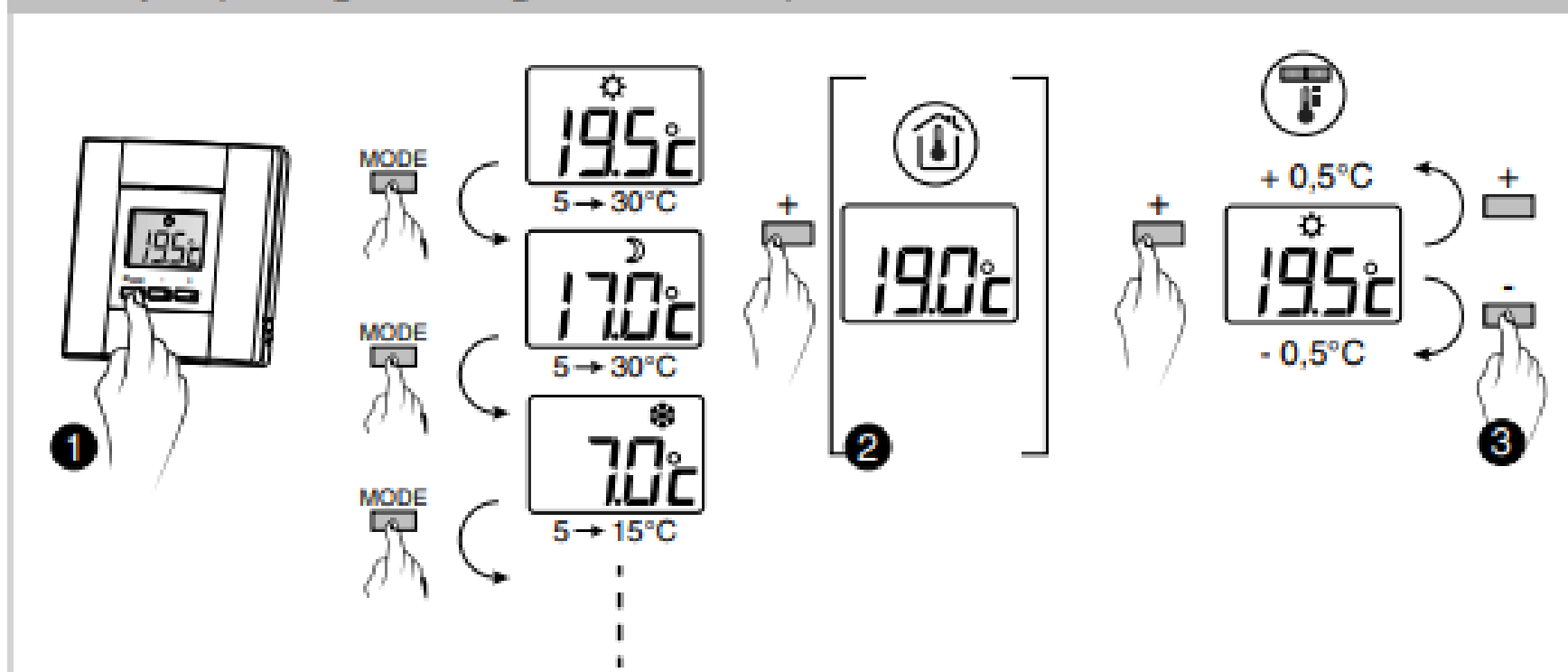

This thermostat is battery-operated.

If it doesn't light up, you may need to change them.

Living room

3.2 Thermostat

Thermostat 2:

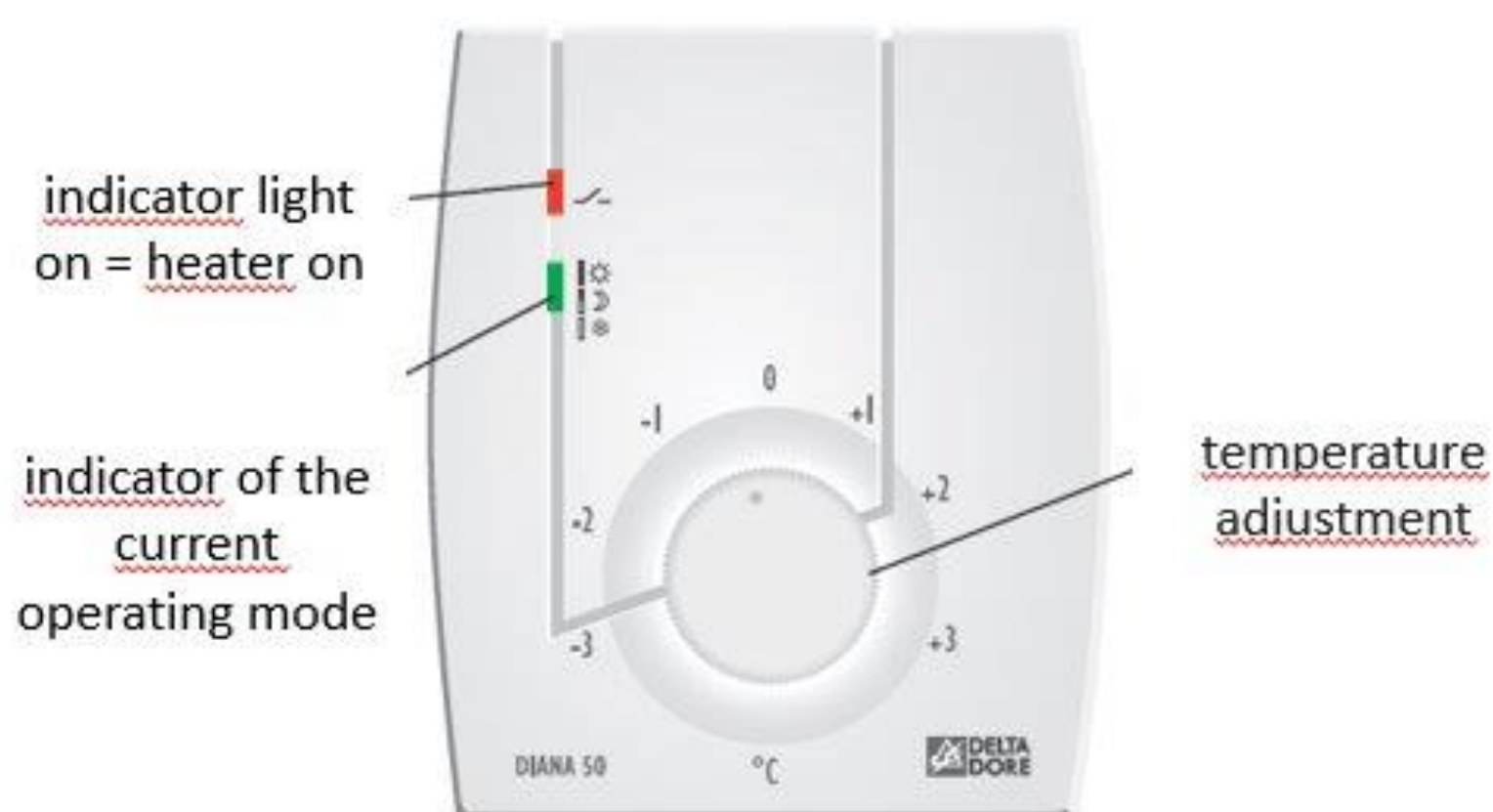

Position -3 = 17°C
Position -2 = 18°C
Position -1 = 19°C
Position 0 = 20°C
Position 1 = 21°C
Position 2 = 22°C
Position 3 = 23°C

Living room

3.2 Thermostat

Thermostat 3:

